

5000 RIDE-ON SCRAPER

OPERATING MANUAL



Read Manual Before Operating Machine

403706 Rev E

Table of Contents

Table of Contents	3
Features and Specifications	4
Safety	5
General Rules For Safe Operation	5
Ride-On Scraper Safety Guidelines.....	6
Hydraulic Safety.....	7
Components and Assembly	8
Charger Instructions	8
Machine Charging.....	8
Transport.....	9
Jobsite Movement.....	9
Cutting Head and Blades.....	10
Foot Pegs	12
Storage	12
Operation	13
Operating Controls.....	13
Start-Up Procedure.....	13
Shut-Down Procedure	14
Slide Plate Adjustments and Settings.....	14
Application Setup.....	15
Ditching.....	16
Headlight.....	16
Maintenance Schedule	17
Troubleshooting Guide	18
Warranty	19

Features and Specifications



FEATURES

Seat Switch - Ensures the machine will not function without someone in the operator seat.

18" Wheels - Designed to work on all types of applications, including debris build-up and slippery/slimy residue (e.g. double stick).

Onboard Battery Charger - Recharges onboard battery.

Adjustable Slide Plate - Affords maximum versatility in blade settings.

Forklift Cups - Makes it easier to load and unload on jobsites.

Control Levers - Move forward or in reverse, turn, and brake with easy-to-move levers.

DC Motor Pump Compartment - Provides easy access to the motor for maintenance purposes.

Adjustable Foot Rests - Adjusts to operator's level of comfort.

Cutting Head Cylinder Lift - Changes the angle of the cutting head via the control handle next to the operator seat.

Debris Deflector - Redirects debris away from the operator.

Swivel Cutting Head - Ensures continuous blade contact with the floor.

Headlight - Illuminates work zone.

Product Specifications						
Width	Length	Height	Weight (Machine Only)	Weight (Fully Weighted)	Power	Speed
24.5" (62 cm)	63" (160 cm)	48" (122 cm)	1,656 lb (751 kg)	2,101 lb (953 kg)	4 HP	Up to 160 ft/min.

Machine Variants			
Region	Serial Number	Input Voltage / Frequency	Body Panels
Domestic (North America)	5000-17XXXX	120V / 60 Hz	Silver Vein
International	5000-11XXXX	230V / 50 Hz	Silver Vein
	5000-15XXXX	230V / 50 Hz	Orange
	5000-20XXXX	110V / 50 Hz	Silver Vein

GENERAL RULES FOR SAFE OPERATION

Before use, anyone operating or performing maintenance on this equipment must read and understand this manual, as well as any labels packaged with or attached to the machine and its components. Read the manual carefully to learn equipment applications and limitations, as well as potential hazards associated with this type of equipment. Keep manual near machine at all times. If your manual is lost or damaged, contact National Flooring Equipment (NFE) for a replacement.

Personal

Dress properly and use safety gear.

Do not wear loose clothing; it may be caught in moving parts. Anyone in the work area must wear safety goggles or glasses and hearing protection. Wear a dust mask for dusty operations. Hard hats, face shields, safety shoes, etc. should be worn when specified or necessary.

Maintain control; stay alert.

Keep proper footing and balance, and maintain a firm grip. Observe surroundings at all times. Do not use when tired, distracted, or under the influence of drugs, alcohol, or any medication that may cause decreased control.

Keep hands away from all moving parts and tooling.

Wear gloves when changing tooling. Remove tooling when machine is not in use and/or lower cutting head to the floor.

Do not force equipment.

Equipment will perform best at the rate for which it was designed. Excessive force only causes operator fatigue, increased wear, and reduced control.

Environment

Avoid use in dangerous environments.

Do not use in rain, damp or wet locations, or in the presence of explosive atmospheres (gaseous fumes, dust, or flammable materials). Remove materials or debris that may be ignited by sparks. Keep work area tidy and well-lit - a cluttered or dark work area may lead to accidents. Extreme heat or cold may affect performance.

Protect others in the work area and be aware of surroundings.

Provide barriers or shields as needed to protect others from debris and machine operation. Children and other bystanders should be kept at a safe distance from the work area to avoid distracting the operator and/or coming into contact with the machine. Operator should be aware of who is around them and their proximity. Support personnel should never stand next to, in front of, or behind the machine while the machine is running. Operator should look behind them before backing up.

Do not come within 3 ft. of the machine's perimeter during operation.

Guard against electric shock.

Ensure that machine is connected to a properly grounded outlet. Prevent bodily contact with grounded surfaces, e.g. pipes, radiators, ranges, and refrigerators. When scoring or making cuts, always check the work area for hidden wires or pipes.

Maintenance & Repairs

Begin maintenance work only when the machine is shut down, unplugged, and cooled down.

Use proper cleaning agents.

Ensure that all cleaning rags are fiber-free; do not use any aggressive cleaning products.

Schedule regular maintenance check-ups.

Ensure machine is properly cleaned and serviced. Remove all traces of oil, combustible fuel, or cleaning fluids from the machine and its connections and fittings. Retighten all loose fittings found during maintenance and repair work. Loose or damaged parts should be replaced immediately; use only NFE parts.

Do not weld or flame-cut on the machine during repairs, or make changes to machine without authorization from NFE.

Equipment

Use proper parts and accessories.

Only use NFE-approved or recommended parts and accessories. Using any that are not recommended may be hazardous.

Ensure accessories are properly installed and maintained.

Do not permanently remove a guard or other safety device when installing an accessory or attachment.

Inspect for damaged parts.

Check for misalignment, binding of moving parts, loose fasteners, improper mounting, broken parts, and any other conditions that may affect operation. If abnormal noise or vibration occurs, turn the machine off immediately. Do not use damaged equipment until repaired. Do not use if power switch does not turn machine on and off. For all repairs, insist on only identical NFE replacement parts.

Maintain equipment and labels.

Keep handles dry, clean, and free from oil and grease. Keep cutting edges sharp and clean. Follow instructions for lubricating and changing accessories. Motor and switches should be completely enclosed at all times with no exposed wiring. Inspect cord regularly. Labels carry important information; if unreadable or missing, contact NFE for a free replacement.

Avoid accidental starting; store idle equipment.

When not in use, ensure that the machine is unplugged and breaker is set to OFF. Store in a dry, secured place. Remove tooling when storing, and keep away from children.

Safety

RIDE-ON SCRAPER SAFETY GUIDELINES

Scraping

Do not drive machine along hills or uneven surfaces.

The weight of the machine may become distributed differently if on an uneven surface. Too much of an angle could make the machine unsafe or cause it to tip over. Always keep the front of the machine facing downward while traveling up or down ramps or inclines. Do not run the machine in unsafe environments.

Inspect work area for potential hazards prior to operation.

Observe location of electrical supplies and extension cords.

Do not allow cutting heads to come into contact with any electrical supply or extension cord.

Operator must be seated before starting machine and should stay seated until motor has stopped running.

This machine is equipped with a safety switch under the seat, which requires the operator to be seated before the machine can be operated. Do not attempt the start-up procedure without first being seated on the machine.

Batteries and Chargers

Use caution; risk of explosive gases.

Batteries generate explosive gases during normal operation. Do not use near fuels, grain, dust, solvents, or other flammables; never smoke near the machine, battery, or charger.

Inspect battery and charger regularly.

Disconnect charger from wall outlet before operating. Machine should be off before connecting to a power source. Periodically inspect batteries, cables, charger, and all plug connections. Be extremely cautious when working with batteries. Do not open or tamper with batteries; doing so could cause electrical shock.

Charger Operation

Ensure proper use of charger.

- Once connected and plugged into AC power, the LED will indicate whether or not it is charging. Refer to manufacturer's charger manual.
- Only use charger on branch circuits protected by a circuit breaker or fuse that can carry the power of the charger.
- Do not use charger if it shows signs of physical stress, or if DC output leads or connector feel hot when used.
- Do not disconnect DC output clamps or connector from batteries while charger is on. This could cause an explosion.
- Failure to unplug AC power before moving equipment will damage cords, plugs, and receptacles.
- Do not over-discharge batteries, this could cause batteries to fail. Re-charge as soon as possible after discharge; if they are warm, first allow them to cool.
- Charger is not water proof, only resistant, and cannot withstand immersion, continuous exposure, or heavy rain.
- A drive lockout option will disable the drive mechanism of the machine while the charger is plugged in.
- There is a built-in Low Voltage Interrupter that continuously monitors for low voltage and will sound when voltage falls. At 44V the alarm will sound; stop immediately and recharge. At 43.5V the machine will auto-disconnect and shut down; let machine sit until batteries recover enough to drive to outlet.
- Chargers are equipped with a grounding plug.

Note: Leaving the charger plugged in does not harm the battery and is preferred to leaving the battery in a state of discharge.



WARNING: BE CAUTIOUS WHEN WORKING WITH BATTERY. IF ELECTROLYTIC ACID GETS IN THE EYES, IMMEDIATELY FLUSH OUT WITH COLD, FRESH WATER FOR AT LEAST 10 MINUTES AND GET MEDICAL HELP.



WARNING: ONLY USE BATTERY/CHARGER CONFIGURATIONS SPECIFICALLY APPROVED BY NFE. USE OF A DIFFERENT OR INCORRECT CONFIGURATION HAS A HIGH RISK OF LEADING TO FIRE, PREMATURE BATTERY FAILURE, DAMAGE TO MACHINE, AND/OR BODILY INJURY.



CAUTION: THE RETURN CAPACITY WHEN CHARGING THE BATTERY IS NOT 1-TO-1. ENSURE THAT BATTERY IS ALLOWED TO CHARGE FOR A GREATER PERIOD OF TIME THAN IT WAS USED (IF NOT COMPLETING A FULL CHARGE). FOR MAXIMUM BATTERY LIFE, FULLY RECHARGE BATTERY (LED WILL APPEAR SOLID GREEN) AT LEAST TWICE PER WEEK. FAILURE TO DO SO MAY RESULT IN SHORTER RUNTIMES AND PREMATURE BATTERY FAILURE.



WARNING: GRINDING/CUTTING/DRILLING OF MASONRY, CONCRETE, METAL AND OTHER MATERIALS CAN GENERATE DUST, MISTS AND FUMES CONTAINING CHEMICALS KNOWN TO CAUSE SERIOUS FATAL INJURY OR ILLNESS, SUCH AS RESPIRATORY DISEASE, CANCER, BIRTH DEFECTS OR OTHER REPRODUCTIVE HARM. IF YOU ARE UNFAMILIAR WITH THE RISKS ASSOCIATED WITH THE PARTICULAR MATERIAL BEING CUT, REVIEW THE MATERIAL SAFETY DATA SHEET AND/OR CONSULT YOU EMPLOYER, THE MATERIAL MANUFACTURER/SUPPLIER, GOVERNMENTAL AGENCIES SUCH AS OSHA AND NIOSH AND OTHER AUTHORITIES ON HAZARDOUS MATERIALS. CALIFORNIA AND SOME OTHER AUTHORITIES, FOR INSTANCE, HAVE PUBLISHED LISTS OF SUBSTANCES KNOWN TO CAUSE CANCER, REPRODUCTIVE TOXICITY, OR OTHER HARMFUL EFFECTS. CONTROL DUST, MIST AND FUMES AT THE SOURCE WHERE POSSIBLE. IN THIS REGARD USE GOOD WORK PRACTICES AND FOLLOW THE RECOMMENDATIONS OF THE MANUFACTURER/SUPPLIER, OSHA/NIOSH, AND OCCUPATIONAL AND TRADE ASSOCIATIONS. WHEN THE HAZARDS FROM INHALATION OF DUST, MISTS AND FUMES CANNOT BE ELIMINATED, THE OPERATOR AND ANY BYSTANDERS SHOULD ALWAYS WEAR A RESPIRATOR APPROVED BY OSHA/MSHA FOR THE MATERIAL BEING CUT.

HYDRAULIC SAFETY

Maintaining a Safe Work Environment

Establishing a safe work environment in and around your hydraulic equipment is extremely important. The easiest and most effective way to avoid problems is to make sure associates understand their equipment, know how to operate the machines safely, and recognize the dangers if handled carelessly. A few things to be aware of are:

- **Pressure:** Hydraulic fluid under pressure is dangerous and can cause serious injury. Never look for a leak when unit is under pressure. Using your hand could cause serious injury. A few common ways to encounter hydraulic fluid under pressure include:
 - Pinhole: Fluid under pressure can cause serious injury. It can be almost invisible escaping from a pinhole, and it can pierce the skin into the body.



DANGER: DO NOT TOUCH A PRESSURIZED HYDRAULIC HOSE ASSEMBLY WITH ANY PART OF THE BODY. IF FLUID PUNCTURES THE SKIN, EVEN IF NO PAIN IS FELT, A SERIOUS EMERGENCY EXISTS. OBTAIN MEDICAL ASSISTANCE IMMEDIATELY. FAILURE TO DO SO COULD RESULT IN LOSS OF THE INJURED BODY PART OR DEATH.

- Leak: Keep fittings and hoses tight. Only check and service when not under pressure. Leaking hydraulic fluid is hazardous; in addition to making workplace floors slippery and dangerous, it also contaminates the environment. Before cleaning an oil spill, always check EPA, state, and local regulations.
 - Burst: Whether due to improper selection or damage, a ruptured hose can cause injury. If it bursts, a worker can be burned, cut, injected, or may slip and fall.
 - Coupling Blow-Off: If the assembly is not properly made or installed, the coupling could come off and hit or spray a worker, possibly resulting in serious injury. Never operate machine without guards.
- **Flammability:** When ignited, some hydraulic fluids can cause fires and/or explode. With the exception of those comprised primarily of water, all hydraulic fluid is flammable (including many “fire-resistant” hydraulic fluids) when exposed to the proper conditions. Leaking pressurized hydraulic fluids may develop a mist or fine spray that can flash or explode upon contact with a source of ignition. These explosions can be very severe and could result in serious injury or death. Precautions should be taken to eliminate all ignition sources from contact with escaping fluids, sprays or mists resulting from hydraulic failures. Sources of ignition could be electrical discharges (sparks), open flames, extremely high temperatures, sparks caused by metal-to-metal contact, etc.



CAUTION: NEVER USE YOUR HANDS TO CHECK FOR LEAKS OVER HOSE OR HYDRAULIC CONNECTIONS. USE A PIECE OF CARDBOARD TO LOCATE A PRESSURIZED LEAK. FOR LOW PRESSURE LEAKS (DRIPS), USE A RAG TO CLEAN THE AREA AND DETERMINE WHERE THE LEAK ORIGINATES.

- **Mechanical:** Hydraulic fluid creates movement, which means some equipment may move. Observe surroundings and equipment at all times.
- **Moisture:** Do not use in wet or high moisture conditions.
- **Electrical:** Faulty wiring can be an electrical hazard. A regular preventive maintenance program should always include a wiring check. If applicable, disconnect battery before servicing.
- **Temperature:** Because this machine operates at a relatively low pressure, overheating is not common. If surface of tank becomes too hot to touch by hand (above 130°F or 55°C), shut off machine and allow it to cool.

Hydraulic Fluid

Only use Texaco Rando 46 Hydraulic Oil or compatible fluid like ISO or AW #46 from a brand name manufacturer. Non-compatible fluids could cause damage to unit or serious injury.

Components and Assembly



FIG. 1

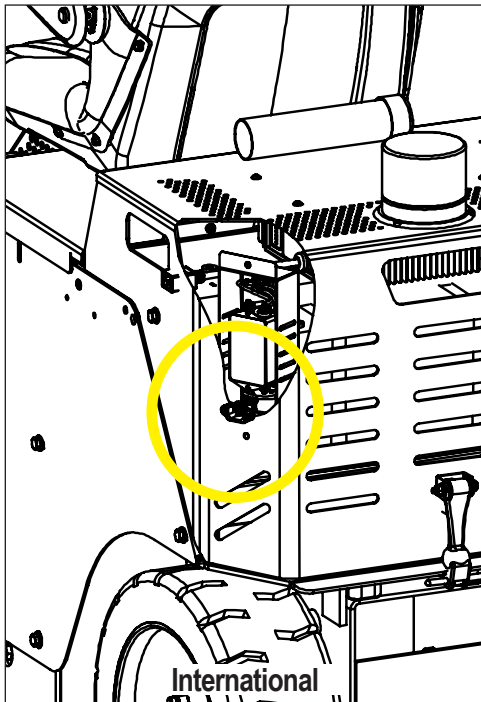

FIG. 1.1

CHARGER INSTRUCTIONS

See Ride-On Safety Guidelines for charger safety and instructions.

Before making AC connections, refer to the requirements on the charger ID label.

This battery charger must be grounded to reduce the risk of electric shock. Chargers are equipped with a grounding type plug.

If an extension cord must be used, ensure it is in good condition. Use the one provided with the machine. The use of an improper extension cord could result in a risk of a fire or electric shock. Locate all cords so that they will not be stepped on, tripped over, or otherwise subjected to damage or stress.

MACHINE CHARGING

This machine has an onboard charger under the hood. See Figure 1 for the domestic machine and Figure 1.1 for the international machine.

1. Connect to power source using the properly sized extension cord. **Note:** *Not using the proper extension cord could cause improper charging and/or charger damage. Only use extension cord provided with machine.*
2. Complete charging sequence. Refer to Charger manual for more details.
3. Disconnect cord from the power source. Ensure cord and plug are completely secured to the machine. **Note:** *Cord can fall under machine which could damage cord and/or plug.*
4. Release red emergency stop button.



CAUTION: WHEN ALARM SOUNDS, IMMEDIATELY MOVE MACHINE TO OUTLET FOR CHARGING.



CAUTION: THE CHARGER IS **NOT** WATER PROOF, IT IS WATER RESISTANT. IT CANNOT WITHSTAND IMMERSION, CONTINUOUS EXPOSURE (SUCH AS PRESSURE WASHERS OR HOSES), OR HEAVY RAIN.



WARNING: DISCONNECT FROM POWER SOURCE BEFORE OPERATING. FAILURE TO DO SO WILL RESULT IN MACHINE NOT OPERATING.



WARNING: ELECTRICAL SHOCK HAZARD. ONLY USE NATIONAL'S APPROVED CHARGING SYSTEM.



WARNING: ALWAYS FIND A SAFE PLACE FOR RECHARGING POWER PACKS WITH GOOD VENTILATION AWAY FROM SPARKS OR FLAME SOURCES AND AWAY FROM BYSTANDERS. ROPE OFF IF NECESSARY.

Components and Assembly

TRANSPORT

- Secure machine with ratchet straps during transport. Proper securing straps need to be rated at least twice the weight of the machine.
- Chock wheels to keep machine from rolling, but do not use them on their own.
- Hydraulic levers should be straight up in the neutral position, not locked in the forward or backward positions.
- Lift machine off swivel caster by lowering cutting head for better stabilization. Use transport wheels when doing this.
- Remove blade, cutting head, and added weights during transport.
- Cutting head and slide plate can be removed to make machine more compact.
- Never leave machine unattended on an incline.



CAUTION: MACHINE IS BACK HEAVY. DO NOT RUN ON STEEP INCLINE THIS COULD CAUSE MACHINE TO TIP OVER! (FIGURE 2). DO NOT USE A RAMP TO MOVE MACHINE.



WARNING: MACHINE HAS A SWIVEL FRONT CASTER. NEVER SIDE HILL (FIGURE 3) THE MACHINE ON A INCLINE WITHOUT POWER, THE FRONT CASTER WILL CAUSE MACHINE TO SWING TO THE LOWEST POINT. IF IT IS NECESSARY TO RUN MACHINE ON AN INCLINE, RUN MACHINE ON CUTTING HEAD. PLACE AT LEAST A 8" CUTTING HEAD IN MACHINE. TO KEEP FROM DAMAGING FLOOR, CLAMP A PIECE OF CARPET INTO CUTTING HEAD. THIS WILL GIVE POSITIVE CONTACT WITH THE FLOOR WHEN POWER IS DISENGAGED FROM THE WHEELS.

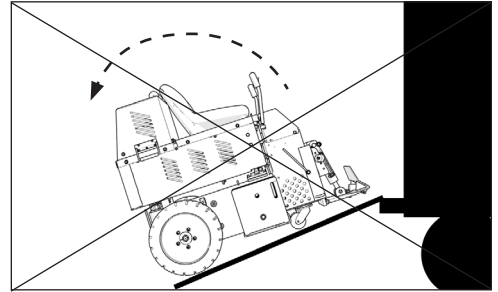

FIG. 2

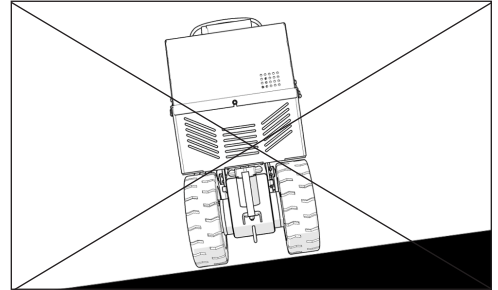

FIG. 3

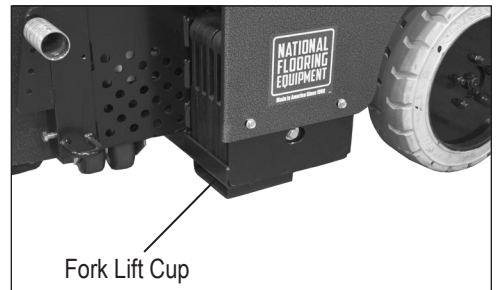

FIG. 4



FIG. 4.1

Dock Heights

It is best to load or unload the machine from a level dock height.

Power Gate

A power gate can be used when the dock height is not available. Ensure gate is properly rated for 3,000 lb (1,361 kg). To better secure machine, place onto the lowered cutting head; raise machine off the caster. Tie machine down and chock wheels.

Forklift Cups

There are two forklift cups mounted under the front of the machine (Figure 4). Slide forklift forks through the cups, then slide as far back as possible (Figure 4.1). Before lifting machine, secure it to the forklift with 3,000 lb (1,361 kg) or heavier straps or a chain. Tilt forks back to lift machine.

Palletizing

Only use a solid platform pallet. If a solid platform pallet is not available, place a piece of $\frac{3}{4}$ " plywood on top of a pallet. Using a forklift, with the forks inserted in the forklift cups, place machine on pallet. Use properly rated ratchet straps to secure machine to pallet.

JOBBSITE MOVEMENT

Taping Wheels

Taping the wheels with a wide masking tape helps to prevent dirtying or damaging the floors during move-in and move-out.

Components and Assembly



FIG. 5

FIG. 6

Transport Wheels

The front wheel assembly is included and very helpful when moving a machine around on a jobsite or loading a machine that is not on a pallet. It allows machine stability and safe transportation over most surfaces. It is quick and easy to attach or detach.

1. Raise slide plate so the bottom of the slide plate is higher or even with the bottom of the guide channels, 6"-8" (15.25-20.3 cm) is ideal.
2. Raise cylinder; insert front wheel assembly into cutting head.
3. Secure with pin.

When finished, the caster wheels should swivel freely and the front wheel plate should be parallel with the floor.

Moving Machine without Power (Pushing Machine)

Forward: To move the machine forward, levers need to be pushed forward. To lock levers in place, connect a bungee strap from each lever (pushing levers forward), pulling straps down to and connecting to the front plate (Figure 5). Never leave machine unattended with strap holding levers open.



WARNING: PROVIDE BARRIERS OR SHIELDS AS NEEDED TO PROTECT OTHERS FROM DEBRIS AND MACHINE OPERATION. OPERATOR SHOULD BE AWARE OF THE PROXIMITY OF OTHERS.

Backward: To move machine backward, levers need to be pulled backwards. To lock levers in place, connect a bungee-strap from each lever (pushing levers backward), Pulling straps to the back of the machine and connecting behind the seat or the rear of the machine (Figure 6). Never leave machine unattended with strap holding levers open.



WARNING: REMOVE STRAPS BEFORE STARTING MOTOR. FAILURE TO DO SO WILL MAKE MACHINE MOVE AND MAY CAUSE DAMAGE AND/OR BODILY INJURY.

Moving Machine on Caster

Moving a weighted machine on only the front caster and not on the cutting head or the front wheel assembly can make the machine sluggish. It may also turn hard to the right or left.

CUTTING HEAD AND BLADES

Matching the correct cutting head, blade size, blade angle, and added weight to the machine is important. For every material being removed, there is an optimum blade width, thickness, sharpness, angle, and bevel (up or down).

The machine is supplied with a 6" and 12" cutting head. Having additional cutting heads will save time on the job. Insert blades into the extra cutting heads before starting a job. When the blade is dull, take out the cutting head and replace it with another.

Shear Point

The shear point is the point where material to be removed will cut cleanly from the floor. If the blade is too wide, too dull, or too steep the shear point is lost.

Inserting the Cutting Head

1. With machine off, insert desired cutting head into cutting head holder.
2. Secure with cutting head clip.

Components and Assembly

Swivel Head

The swivel head keeps the blade in contact with the floor even when the floor is uneven. When using a flat blade, turning the head over 180° provides another sharp edge on the blade without having to replace the blade.

Inserting or Changing Blades

Sharp blades are imperative for good performance.

1. Using a 3/4" socket wrench, loosen bolts on cutting head. Quantity of bolts will vary depending upon cutting head size.
2. Insert blade into the cutting head to back of notch (Figure 7); tighten firmly.

Note: A cordless 3/8" drive impact wrench will speed up this process.

Inserting a Shank Blade

Shank blades do not require a cutting head.

1. Insert desired shank blade into cutting head holder.
2. Secure with cutting head clip.

Self-Scoring Blades

Instead of pre-scoring a job for soft goods (e.g. carpet, vinyl, linoleum, membrane), the self-scoring blades automatically do the scoring.

Sharpening Blades



WARNING: BLADES ARE SHARP, USE EXTREME CAUTION. ALWAYS WEAR GLOVES AND SAFETY GLASSES WHEN HANDLING BLADES. NEVER CHANGE CUTTING HEAD OR SERVICE BLADES WHILE MACHINE IS RUNNING.

Dull blades greatly reduce cutting ability. Sharpen or replace as needed. In use, blades develop a back-bevel. When sharpening, blade will not be completely sharp until all back-bevel is gone (Figure 8).

Note: Thinner blades are easier to sharpen, but they also break easier.

- Grind blade using a 4" diameter disk with 120 or finer grit. Be careful not to catch disk on edge or corner of blade.
- Pass grinder along blade edge starting on one end and continuing in one direction, being careful to hold grinder at proper angle of blade. Grind until sharp.
- When using a high quality fine tooth hand file, follow the same procedure as above.
- Have plenty of sharp blades on each job so on-the-job blade sharpening is eliminated.
- It is best to sharpen dull blades on proper bench or belt grinder in the shop, so the blades are ready for the next job.

Self-Scoring Blade Sharpening: It is important to keep the "wings" on a self-scoring blade sharp. Use a file on the wing edge (Figure 8). Sharpen the flat part of the blade, the same way as described above.

Carbide-Tipped Blade Sharpening: To sharpen carbide tipped blades, a carbide grinding wheel is necessary, e.g., silicon carbide or green wheel.

Blade Setting

- Proper blade size and placement, depending on material and sub-floor type, affects performance.
- For better results during difficult removal applications use a smaller blade.

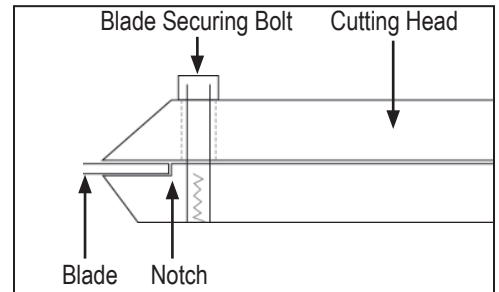

FIG. 7

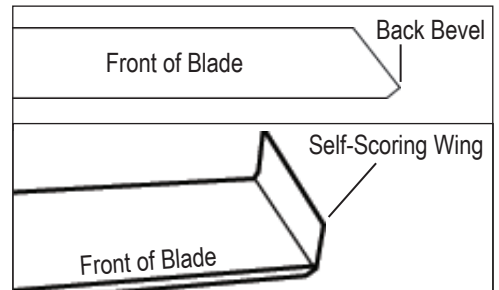

FIG. 8

Components and Assembly

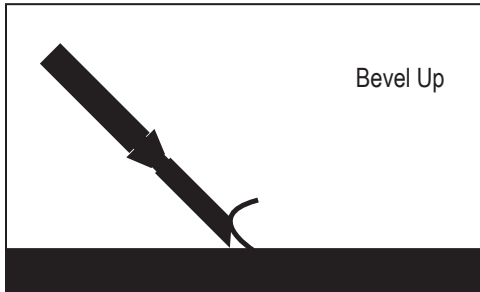

FIG. 9

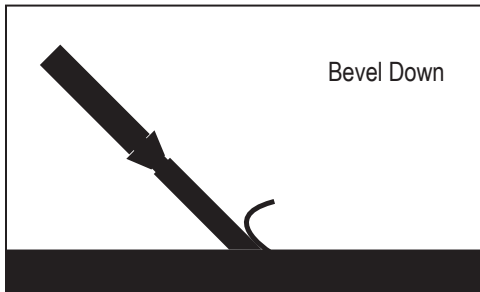

FIG. 9.1

- Start with a narrow blade, then increase blade size to optimize cutting pass. Narrower blades work easier than wider blades and usually clean the floor better. Wider is not always better or faster.
- Normally, bevel on blade is up for concrete (Figure 9); bevel down for wood (Figure 9.1)
- Dull blades greatly affect the performance of the machine and reduce cutting ability, sharpen or replace as needed.
- After removing a portion of material, clear the work area of debris. This will give the machine maximum performance and help to keep the work area safe.

FOOT PEGS

Rest feet on foot pegs while operating machine. Foot pegs are adjustable. Ensure securing knob is tightened.

STORAGE

When the machine is in storage, disconnect the blue plug (Figure 10) and turn circuit breaker to "OFF" (Figure 11).

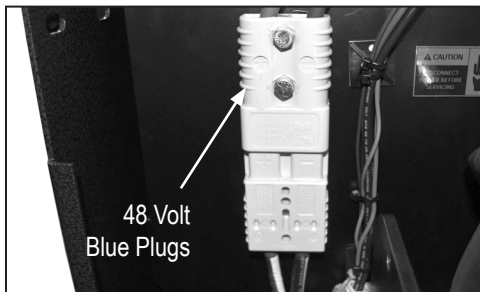

FIG. 10

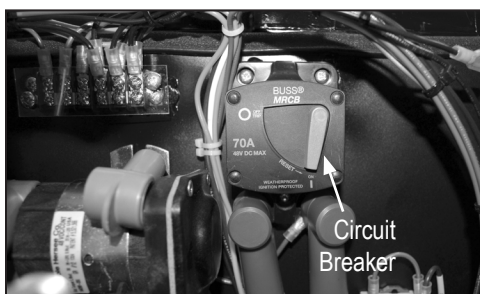

FIG. 11

OPERATING CONTROLS

Power On Button/Key (Figure 12)

Never use the Power On button/key as a method for speed control. Speed control is achieved by the hydraulic valve only. Using the On/Off switch repeatedly will cause excessive wear and premature failure of electrical components.

Hydraulic Levers (Figure 13)

The hydraulic levers steer the machine. For even movement, move levers slowly. Fast movement of control levers will result in jerky, uneven movement.

- To move the machine forward, push both levers forward $\blacktriangle\blacktriangle$.
- To move the machine in reverse, pull both levers backward $\blacktriangledown\blacktriangledown$.
- To turn the machine quickly to the right, move the left lever forward and the right lever backward $\blacktriangle\blacktriangledown$.
- To turn the machine quickly to the left, move the left lever backward and the right lever forward $\blacktriangledown\blacktriangle$.
- To turn the machine slowly to the right or left, push or pull only the right or left lever forward \blacktriangle or \blacktriangledown .
- Putting the levers in the center/neutral position causes the wheels to lock-up.
- Correcting direction while moving forward is accomplished by slightly reducing pressure on one lever or the other while moving.

Emergency Stop Switch (Figure 14)

The emergency stop switch is designed to immediately cut power to the system.

Seat Switch

The seat has a safety switch. Operator must be properly positioned for machine to run.

Cylinder Lift Lever (Figure 15)

The cylinder lift lever raises and lowers the cylinder and cutting head. After setting the slide plate to proper height, use the cylinder lift lever to set blade to proper cutting angle.

- To raise the cutting head, pull back \blacktriangledown on the cylinder lift lever.
- To lower the cutting head, push the cylinder lift lever forward \blacktriangle .
- Continuing to push the cylinder lift lever forward will adjust the angle of the cutting head. This will also jack up the front of the machine for maintenance purposes.

START-UP PROCEDURE

1. Verify 70 Amp circuit breaker is in ON position (Figure 16).
2. Verify 48V blue plugs are firmly connected.
3. Operator should be properly positioned on seat.
4. Twist emergency stop (Figure 14) up.
5. Push green ON button (domestic only) or turn the key (international only).
6. Maneuver machine with hydraulic levers (Figure 13).

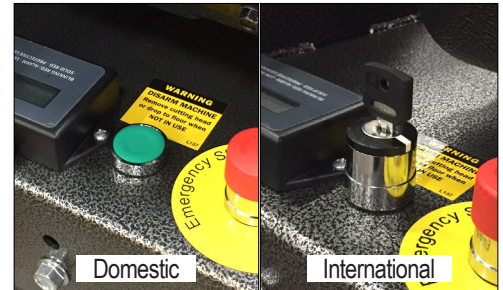

FIG. 12



FIG. 13



FIG. 14



FIG. 15

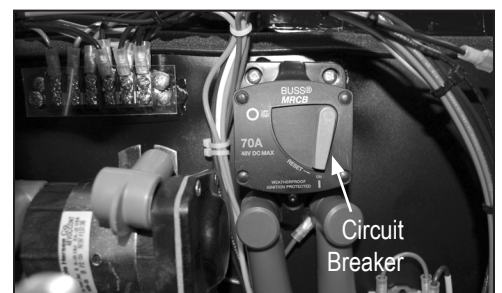

FIG. 16

Operation



FIG. 17



FIG. 18

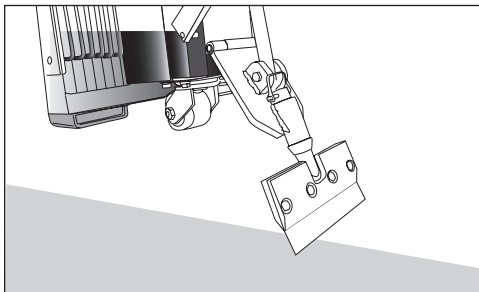

FIG. 19

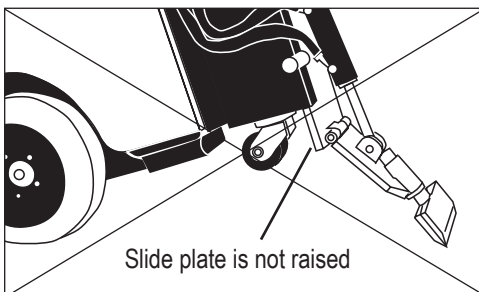

FIG. 19.1

SHUT-DOWN PROCEDURE

The machine will stop when the operator is no longer seated, or when the emergency stop is engaged.

Remove blade or drop cutting head to the floor when machine is not in use.

SLIDE PLATE ADJUSTMENTS AND SETTINGS

Dual Lift (Figure 17)

- Prior to adjusting the dual lift hydraulic slide plate, ensure the channel guide is free of any debris and the machine is safely positioned on a flat surface.
- To set the height of the hydraulic slide plate start, adjust the angle of the cutting head holder with the cylinder lift lever. Pull back on the cutting head lever and raise the cutting head holder to an angle higher than the bottom of the slide plate.
- The lever adjacent to the right hand control lever (Figure 18) raises and lowers the hydraulic slide plate. To lower the slide plate, push forward on this lever. To raise the slide plate, pull back on the lever.

Slide Plate Settings

While the hydraulic slide plate can be adjusted to multiple positions, there are two basic slide plate settings:

- **Low Setting (Figure 19):** the hydraulic slide plate is positioned 1" off the floor. This setting is most commonly used during initial scraping or removal applications; such as carpet, VCT, ceramic tile and wood flooring. **Note:** The "low" setting on older model hydraulic slide plates may stop the plate within one to two inches of the floors surface.
- **High Setting (Figure 19.1):** the hydraulic slide plate is positioned 6" off the floor or in most cases flush with the bottom of the slide plate channel guide. This setting is most often used for re-scraping glues, mastics, thin sets and soft coating.

Steep Cutting Head Angle

A steep angle is only used for re-scraping. The slide plate has to be raised so the bottom of the plate is higher or even with the bottom of the guide channels (Figure 19). Raising the slide plate to an angle too steep when operating will cause the machine to jump and buck. It does not give the operator a clear vision of the cutting head and it raises the machine to operate at a unsafe height (Figure 19.1).

APPLICATION SETUP

Ceramic (Figure 20)

The slide plate should be adjusted to a low setting 1" (2.5 cm) off the floor. Use a shank blade or a shank blade with a carbide tip.

Wood

The slide plate should be adjusted to a low setting 1" (2.5 cm) off the floor. Use shank blades, shank blades with carbide tips, or a 6" or 8" (15-20 cm) cutting head with heavy duty blades.

Note: Run machine 45° to the grain of the wood.

Secondary Backing Carpet

The slide plate should be adjusted to a low setting 1" (2.5 cm) off the floor. Use a cutting head from 10"-27" (25-68 cm) with heavy duty blades or a cutting head from 10"-14" (25-35 cm) with a self-scoring blade.

Foam Back Carpet

The slide plate should be adjusted to a low setting 1" (2.5 cm) off the floor. Use cutting heads from 10"-14" (25-35 cm) with self-scoring blades. If it is not stuck tight, use a cutting head from 14"-27" (35-68 cm) with a standard blade.

Double Stick Carpet

The slide plate should be adjusted to a low setting 1" (2.5 cm) off the floor. It is best to test to see which is the easiest way to remove double stick. Start with a cutting head from 10"-14" (25-35 cm) with self-scoring blades (Figure 21). Use self-scoring blades with 4" wings, 6" or 12" wide for best results. In some cases, carpet might pull off the pad and then scrape up the pad separately. Usually leaving carpet connected to the pad works the best. Sharp blades are necessary for proper operation.

Note: When removing carpet from over VCT tile and the tile needs to be saved, run the machine at a 45° angle over the tile. This should help to save the tile.

Vct Tile

The slide plate should be adjusted to a low setting 1" (2.5 cm) off the floor. If goods come up easily, change to a larger cutting head. If goods come up harder, use a cutting head from 6"-8" (15-20 cm) with a premium high-tempered blade (.062) to match cutting head size. Sometimes a .094 blade may work better. If goods remove easily, a tile box (#7074) can be used. A tile box also works for wind rowing, and assists for a fast clean-up and collection of tile debris for quick removal.

Rubber Tile

The slide plate should be adjusted to a low setting 1" (2.5 cm) off the floor. Use a cutting head from 6"-14" (15-35 cm) with self-scoring blades or use ditching method with a flat blade.

Re-Scraping

Slide plate should be set high, 6"-8" (15-20 cm) off the floor. Use a cutting head from 8"-27" (20-68 cm) with scraper blades to match cutting head size. A 15" (38 cm) scraper blade would use a 14" (34 cm) cutting head. Razor blades are faster but a cutting head from 8"-14" (20-35 cm) can be used with a standard blade. Flip head regularly.

Thin Coating and Glues

Slide plate could be set high, 6"-8" (15-20 cm) or low 1" (2.5 cm) off the floor. Test to see which works best. Use a cutting head from 8"-27" (20-68 cm) with razor blades to match cutting head size.

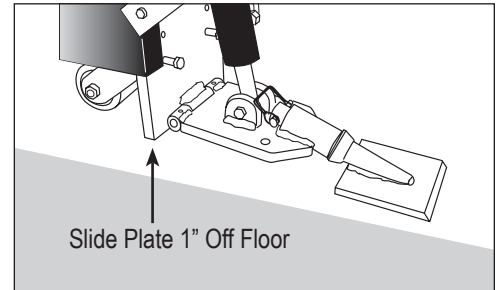

FIG. 20

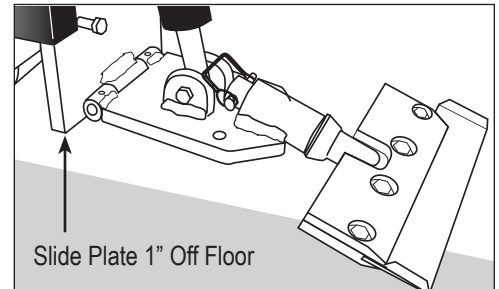
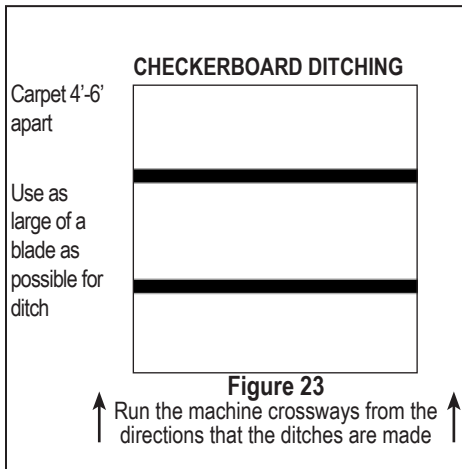
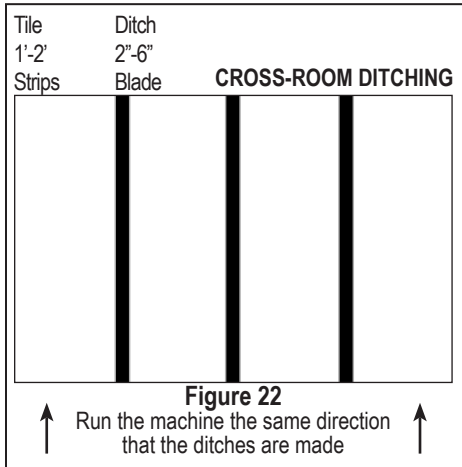

FIG. 21

Operation



Concrete

Blade should be bevel up when working over concrete. Pretty much anything over concrete works. Try different setups to see which works best. If goods come up difficult, the slide plate should be at a low setting, 1" (2.5 cm) off the floor. Use a smaller size blade. If goods come up easily, a wider blade can be used.

Wood Sub-Floor

A heavy machine cannot be used on wood subfloors or raised panel computer floors. Keep machine light; remove all weights. A weighted machine could break through the floor. The slide plate should be adjusted to a low setting, 1" (2.5 cm) off the floor. Blades should be as flat of an angle as possible. Use a heavy duty blade (these blades have a bend to them) or a regular blade bevel down. When using a regular blade, bending up the corners of the blade will help from the blade digging into the floor. Sometimes a shank blade or a shank blade with a carbide tip will work. Allow blade to shear material from the floor. The trick on wood floors is to run the blade flat. Approach should be at a 45° angle to the board. This keeps from digging into the board and hanging up at the seams.

Soft Sub-Floor

The slide plate should be adjusted to a low setting 1" (2.5 cm) off the floor. Blades should be as flat of an angle as possible. Use a heavy duty blade (these blades have a bend to them) or a regular blade bevel down. When using a regular blade, bending up the corners of the blade will help from the blade digging into the floor. Sometimes a shank blade or a shank blade with a carbide tip will work.

DITCHING

Cross Room Ditching (Figure 22)

When removing hard to remove ceramic, VCT, or VAT, cross-room ditching will help to make the removal easier. Using a blade 2"-6" (5-15 cm) in width, make ditches 1'-2' (30-60 cm) apart in the same direction the machine will be removing the goods. This relieves the pressure holding the tiles together. If ditching helps and the goods are coming up easy, try using a wider blade to ditch with.

Checkerboard Ditching (Figure 23)

To make carpet removal and debris clean-up easier, checkerboard ditching is very helpful. Using as wide of a self-scoring blade as possible, make ditches 4'-6' (1.25-1.75 m) crossways from the way the machine will be removing the goods. Running the machine crossways from the ditches will make smaller pieces of debris to be hauled away. Instead of large gummy rolls of carpet, there are small squares that can be rolled, palletized, put on a dolly, or folded with the sticky side in. This makes removing the debris easier and reduces the amount of debris.

HEADLIGHT

The headlight illuminates the work zone.

- Use the toggle switch to turn the headlight ON and OFF. *NOTE: The headlight only operates when the machine is running.*
- The light is fixed-mounted with fixed brightness--it is not adjustable.

Maintenance Schedule

Maintenance to be performed	Interval					
	Daily	200 hrs	1000 hrs	2000 hrs	After initial 100 hrs	After initial 500 hrs
Inspect extension cord for damage	•					
Check wheels, caster and wheel motors for build up; and clean	•					
Inspect all safety devices (e-stop, backup beeper, seat switch)	•					
Inspects for leaks (hoses and fittings)	•					
Blow out fan cover on the bottom of the motor after each job	•					
Grease front caster wheel			•			
Check hydraulic oil level		•			•	
Replace the spin-on hydraulic oil filter		•			•	
Change hydraulic fluid			•			•

It is recommended to perform initial maintenance during the break-in period when first operating the machine. After the first 100 operating hours the hydraulic oil level should be checked and the spin-on hydraulic oil filter should be replaced, then every 200 hours thereafter. At the 500 operating hour mark the hydraulic fluid should be changed. Regular maintenance should be performed according to the schedule.

Note: For additional maintenance and repair information, reference this machine's Service Manual.

Troubleshooting Guide

Problem	Cause	Solution
Machine will not start.	Seat safety switch is disengaged.	Ensure operator is seated.
	Emergency stop (E-Stop) switch is disengaged.	Twist E-Stop so that it is in the "POWER ON" position.
	Circuit breaker is in the "OFF" position.	Verify circuit breaker is in "ON" position.
	48 volt blue plugs are not connected.	Make sure that connection plugs are fully installed.
	Wire harness is disconnected.	Connect wire harness.
	Batteries are low.	Charge batteries.
Machine doesn't run as long as it used to.	Battery is not fully charging.	Verify that battery is being properly charged.
		Verify that charger is working properly. Charger has a LED light to indicate.
	The 48 volt blue plugs are not connected.	Check that connection plugs are fully installed.
	Batteries no longer hold a charge.	Call NFE for procedure.
	Motor fan cover plugged with dust or debris.	Blow out fan cover after each job.
Machine is making rattling noises.	Loose hardware on machine.	Inspect and tighten bolts as needed.
Charger is hot.	Charger is in use.	This is normal.
Fluid is leaking from machine.	Hose connections/or fittings have loosened through normal use.	Tighten hydraulic hoses and fittings as needed.
	Pin hole in the hoses.	Replace affected hose.
	Oil and/or oil filter are old.	Replace oil and oil filter yearly on machine.
Tires/Wheel motors make a slight clicking noise.		Normal noise with proper operation.
Machine is jerky or jumpy.	New operator.	Additional time is required to become familiar with machine.
	Control levers are being moved too quickly.	Operate control levers with wrists resting on knees or arm rests.
Coupling leaks at thread or seat.	Missing or damaged O-rings.	Check for missing or damaged O-rings; replace if necessary.
	Damaged threads due to misalignment or improper seat angle.	Correct seat angle. Check for thread damage; replace if necessary.
	Over or under torquing.	Only hand-tighten hardware.
Any issues not listed above.		Contact NFE to speak with a technician.

Note: For additional maintenance and repair information, reference this machine's Service Manual.

Warranty

National Flooring Equipment Inc. (referred to as "The Company") warrants that each new unit manufactured by The Company to be free from defects in materials and workmanship in normal use and service for a period of twelve (12) months from date of shipment from The Company to the end user. If shipment to end user is from a Distributor, The Company may honor warranty for up to 15 months from initial shipment from the Company if the end user can provide documentation of receipt date. Accessories or equipment furnished and installed on the product by the Company but manufactured by others, including but not limited to: engines, motors, electrical components, transmissions etc., shall carry the accessory manufacturers own warranty. Battery warranties are prorated over the warranty period. Customer is responsible for the inspection of equipment or parts upon delivery. **Freight damages are excluded from this warranty.**

The Company, at its determination of defect, will repair or replace any product or part deemed to be defective in material or workmanship within specified warranty time period. All product determinations and / or repairs will take place at The Company repair facility or at a certified warranty location designated by The Company. The Company will coordinate and be responsible for all freight expenses associated with valid warranty claims. Freight and shipping expenses associated with abuse or misuse will be back charged to the Distributor/Customer. The Company reserves the right to modify, alter or improve any part / parts without incurring any obligation to replace any part / parts previously sold without such modified, altered or improved part / parts. In no event shall the seller or manufacturer of the product be liable for special, incidental, or consequential damages, including loss of profits, whether or not caused by or resulting from the negligence of seller and / or the manufacturer of the product unless specifically provided herein. **This warranty shall not apply to any products or portions there of which have been subjected to abuse, misuse, improper installation or operation, lack of recommended maintenance, electrical failure or abnormal conditions, and to products which have been tampered with, altered, modified, repaired, reworked by anyone not approved or authorized by the Company or used in any manner inconsistent with the provisions of the above or any instructions or specifications provided with or for the product.** Any and all unauthorized onsite warranty work conducted by unauthorized personnel or any outside person(s), is not covered by The Company unless the work has been pre-authorized by a predetermined manufacturer representative. This warranty excludes wearable parts and/or consumables.

Defective or failed material or equipment shall be held at the purchaser's premises until authorization has been granted by The Company to return or dispose of defective products. Products returned to The Company for inspection must be returned with a manufacturer authorized Return Material Authorization (RMA), and must be packaged to The Company's specifications to avoid damage during shipment. Any unauthorized return of equipment will be declined at the dock by The Company. Any non-approved items returned with approved returned items are subject to rejection and will not be credited. Credit will be issued for material found to be defective upon The Company's inspection based on prices at time of purchase.

TO OBTAIN SERVICE CONTACT NATIONAL FLOORING EQUIPMENT, INC. TOLL FREE AT 800-245-0267 FOR A REPAIR AUTHORIZATION NUMBER. COD FREIGHT RETURNS WILL NOT BE ACCEPTED. FREIGHT COLLECT SHIPMENTS WILL NOT BE ACCEPTED. WARRANTY REPAIRS MUST BE ACCOMPANIED BY DATE OF PURCHASE RECEIPT AND A RETURN/ REPAIR AUTHORIZATION NUMBER.

RETURN/REPAIR AUTHORIZATION NUMBER: _____

MACHINE SERIAL NUMBER: _____



Made in America Since 1968

9250 Xylon Avenue N • Minneapolis, MN 55445 • U.S.A.
Toll-free 800-245-0267 • Phone 763-315-5300 • Fax 800-648-7124 • Fax 763-535-8255
Web Site: www.nationalequipmentdirect.com • E-Mail: info@nationalequipment.com